

Title	Lossy Forwarding HARQ for Parallel Relay Networks
Author(s)	Irawan, Ade; Anwar, Khoirul; Matsumoto, Tad
Citation	Wireless Personal Communications, 95(2): 915-930
Issue Date	2016-11-14
Type	Journal Article
Text version	author
URL	http://hdl.handle.net/10119/15064
Rights	This is the author-created version of Springer, Ade Irawan, Khoirul Anwar, Tad Matsumoto, Wireless Personal Communications, 95(2), 2016, 915-930. The original publication is available at www.springerlink.com , http://dx.doi.org/10.1007/s11277-016-3805-8
Description	

Lossy Forwarding HARQ for Parallel Relay Networks

Ade Irawan · Khoirul Anwar · Tad Matsumoto

Received: date / Accepted: date

Abstract This paper proposes Lossy-Forwarding Hybrid Automatic Repeat reQuest (LF-HARQ) schemes to improve bit-error-rate (BER), packet-error-rate (PER) and throughput performances of dual-hop wireless parallel relaying systems. In contrast to the conventional lossless decode-and-forward schemes, where erroneous packets are always discarded at the relay, we introduce Lossy-Forwarding concept to HARQ technique that allows the relay nodes to forward them to the next hop, referred to as Fully LF-HARQ (FLF-HARQ) scheme. We then propose Partially LF-HARQ (PLF-HARQ) scheme, where the relaying nodes select either forwarding the erroneous packets or requesting retransmission. The mode selection is based on the confidence indicator (CI) expressing the reliability of the received packets. Since the channels are assumed to suffer from block Rayleigh fading, the CI is calculated via online measurement of mutual information, block-by-block. Results of computer simulations to verify the superiority of the proposed techniques are presented.

Keywords hybrid ARQ · lossy forwarding · iterative decoding · relay networks · multihop

1 Introduction

Multihop relay networks have long been considered very beneficial for enhancing throughput and coverage of cellular wireless communication systems [1]. Furthermore, it has a ca-

A. Irawan
School of Information Science, Japan Advanced Institute of Science and Technology (JAIST), 1-1 Asahidai,
Nomi, Ishikawa, JAPAN 923-1292
E-mail: ade.irawan@jaist.ac.jp

K. Anwar
School of Information Science, JAIST, 1-1 Asahidai, Nomi, Ishikawa, JAPAN 923-1292
E-mail: anwar-k@jaist.ac.jp
on leave to Telkom University, Jl. Telekomunikasi Terusan Buah Batu, Bandung, Indonesia 40257

T. Matsumoto
School of Information Science, JAIST, 1-1 Asahidai, Nomi, Ishikawa, JAPAN 923-1292
E-mail: matumoto@jaist.ac.jp
and
Center for Wireless Communication, University of Oulu, FI-90014 Finland
E-mail: tadashi.matsumoto@ee.oulu.fi

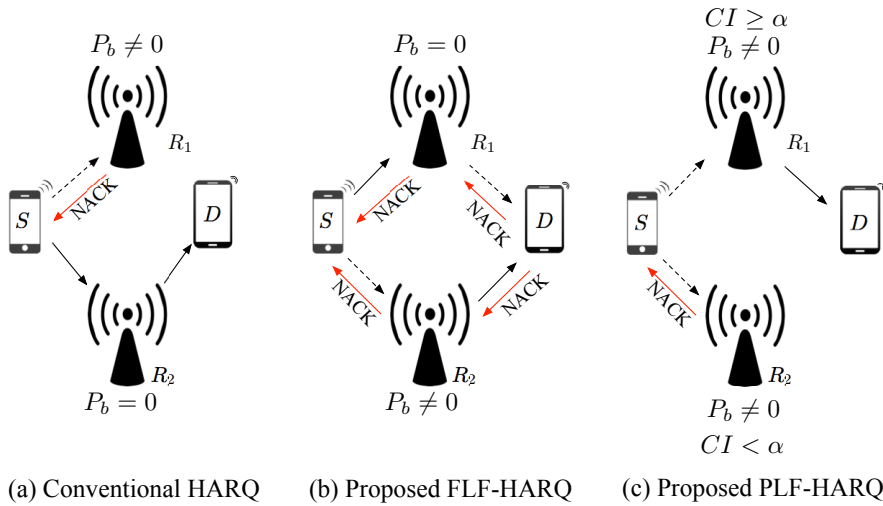

Fig. 1 Multihop relaying comparison between the conventional and the proposed HARQs.

pability of reducing the overall path loss between the source node and the destination node with the help of relay(s) in between. However, the end-to-end delay with multihop systems may be larger compared to that of the single-hop case due to the processing required in each hop to guarantee the reliability of the systems.

Lossy forwarding (LF) technique—a technique allowing erroneously decoded packets to be forwarded—is effective in reducing the end-to-end latency and increasing the throughput of multihop relay networks. One way to utilizing the LF concept is the soft relaying technique [2]. Specifically, the relay node uses a soft decoder to derive the *a posteriori* probabilities of the coded bits, and then forwards the soft values, which are exploited as *a priori* information by the soft decoders to improve decoding performance. However, the main disadvantage of the technique is that it requires additional bandwidth and power consumption, due mainly to the requirement for transmitting the soft values or their quantized versions.

In parallel link relaying systems as presented in [2], erroneously decoded packets at the relay node can be forwarded by re-interleaving and re-encoding them in such a way that the destination can exploit the correlation of the information parts of the packets received via all links. In fact, the correlation exists because the packets are generated from the same source. Nevertheless, in conventional decode-and-forward relaying, the erroneously decoded packets are discarded at the relay.

Multiple copies of correlated packets are received not only from parallel links but also from retransmitted packets following an automatic repeat request (ARQ) protocol. In multihop relay systems, conventional ARQ protocol always requests the source node to retransmit whenever the destination node failed in recovering the packet. This end-to-end ARQ is a very simple mechanism to ensure the successful recovery of the packets at the destination node, but larger transmission delay is a detrimental drawback. Hence, additional techniques initiated by the relay nodes are needed, for instance, the hop-by-hop ARQ proposed by [3], and the relay ARQ by [4]. Reference [5] shows that the delay increases exponentially as the packet-error-rate (PER) per link in two-hop transmission increases, and the hop-by-hop

ARQ, as well as the relay ARQ mechanism, perform similar even though they outperform the end-to-end ARQ in term of throughput. The superior performance of the hop-by-hop ARQ and the relay ARQ over the end-to-end ARQ is shown in [5], also in terms of throughput.

Every time a packet is retransmitted, the receiving node will increase the amount of information. Hence, by accumulating sufficient information, the node will be able to decode the message. In this case, ARQ based on packet combining techniques with forward error correction (FEC) in a hybrid ARQ (HARQ) scheme can achieve not only coding gain but also the time diversity through retransmissions, as well as the spatial diversity through the relays which retransmit the source information, as described in [6]. Therefore, employing HARQ in multihop relay networks can further improve the reliability.

Many different schemes of HARQ for multihop relay networks have been proposed in the literature, for example, the HARQ for one-relay-per-hop systems in [7, 8, 9]. Those protocols may not be optimal, however, for a system with parallel relay links, as shown in Fig. 1, since the spatial diversity is not taken into consideration. The system becomes more complex as the number of relays per hop increase as shown in Refs. [10, 11, 12]. However, the relay node of those systems does not forward erroneous packets, but instead requests for retransmissions, as shown in Fig. 1a, and hence the end-to-end latency increases. Furthermore, they do not consider the correlation between more than two information sequences so that no aim for further potential improvement utilizing the knowledge of it.

This paper proposes LF HARQ techniques for multihop parallel relay networks, which utilizes the knowledge of the correlation between the information sequences in the decoding process. The proposed techniques are based on the concept presented in [13]. However, this paper considers the network topology that has no direct link between the source and the destination while [13] does assume the direct link. In this paper, we further extend the technique for combining-after-decoding Turbo HARQ [14] to parallel relay networks with end-to-end ARQ protocol to preserve packets received via as many parallel links as possible to achieve larger diversity gain. This technique is referred to as Fully LF HARQ (FLF-HARQ), as shown in Fig. 1b.

On the other hand, forwarding packets having significant distortions may invoke continuously retransmission request to the source node, resulting in reduced end-to-end throughput. Moreover, the capability of correcting errors in a parallel network systems at the destination node is made possible regardless the qualities of each link, so far as there is at least one connection where errors are not introduced in the relay before re-encoding. FLF-HARQ case has no control to guarantee the non-error packets at relay. To solve the problem, we propose Partially LF HARQ (PLF-HARQ) which introduces a confidence indicator (CI) as a threshold by which a relay node decides either forwarding the erroneous packet or requesting retransmission, as shown in Fig. 1c.¹ Therefore, the end-to-end bit-error-rate (BER) and PER performances can be improved because PLF-HARQ increases the reliability retransmission-by-retransmission.

PLF-HARQ scheme with binary shift keying (BPSK) modulation is presented in [15]. In this paper, given the received signal to noise power ratio (SNR) fixed, we apply the technique to a higher-order modulation, quaternary phase shift keying (QPSK), where the error probability is worse than with BPSK, and hence PLF-HARQ is expected to achieve larger efficiency improvement.

¹ Compared with CRC, CI has capability of identifying multiple levels of reliability of the entire one block packet.

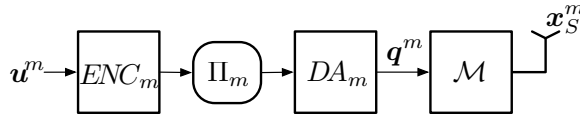

Fig. 2 Block diagram of the source during transmit phases.

The remainder of this paper is organized as follows. The considered system model is presented in Section 2. In Section 3, the proposed FLF-HARQ and PLF-HARQ mechanism is introduced, where the brief mathematical expression for the CI calculation is provided. Results of the extrinsic information transfer (EXIT) chart analyses provided in Section 4 are used to verify the numerical results presented in Section 5. We evaluate the BER, the PER, and the throughput performances of FLF-HARQ and PLF-HARQ, and make a performance comparison with SHARQ I and SHARQ II [12] techniques. Finally, Section 6 concludes this paper.

Throughout this paper, vectors are expressed with bold lowercase, while scalars are with standard text notation.

2 System Model

This section discusses the system model assumed in this paper. We divide the model to (a) transmit phase, and (b) receive phase. The source node S is in transmit phase, while the destination node D is in receive phase, and the relay nodes are in either transmit or receive phases, at alternate timings.

2.1 Transmit Phase

We consider an orthogonal dual-hop parallel relay network where S aims to transmit information sequence to D through two relay nodes R_1 and R_2 that are located physically separately in the parallel links, as shown in Fig. 1.

We assume time-division channel allocation to guarantee orthogonal transmission, and hence one transmission cycle consists of three-time slots. In the first time slot, the node S broadcast its coded sequences x_S to the nodes R_1 and R_2 . The following time slots, the both relays transmit their coded sequence $x_{R_l}, l \in \{1, 2\}$ to the destination D , sequentially. We consider static channel within one block but varying link-by-link as well as transmission-by-transmission during HARQ rounds. We use the terminologies transmitting nodes and receiving nodes, for referring to the source node and the relay nodes for the transmit phase, and the relay nodes and the destination node for the receive phase, respectively.

Fig. 2 depicts the transmitter structure of the source node, which has the same structure as the relay node, as shown in Fig. 3. With m (re)transmissions, $m \in \{1, 2, \dots, M\}$, where the maximum number of retransmissions is $M - 1$, the binary information sequence u^m is first encoded by the channel encoder ENC_m . For the retransmit phases, at the relay node, the estimated u^m, \tilde{u}^m , from a buffer is first random-interleaved by inner interleaver $II_{0,m}$ before being encoded. The use of the different interleaver for each transmission by the relays converts the system into a distributed Turbo Code. The relay node discards the old packet in the buffer whenever receiving a new packet. The same process is performed at the other relay for the first transmission. The encoded bit sequence is then randomly interleaved by

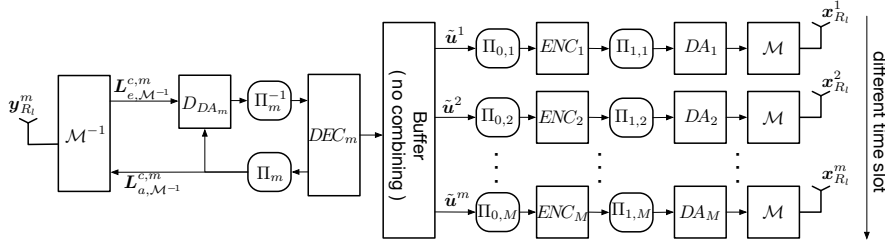

Fig. 3 Block diagram of the relay node $R_l, l \in \{1, 2\}$ during receive and transmit phases.

outer interleaver $\Pi_{1,m}$ followed by doped-accumulator DA_m with doping ratio $\rho = \rho^m$.² The outer interleaver enables extrinsic LLR exchange for the systematic bits at the receiver side, as detailed in the next subsection.

The k doped-accumulated bits in sequence \mathbf{c}^m ,

$$\mathbf{q}^m = [c_i^m(1), c_i^m(2), \dots, c_i^m(v), \dots, c_i^m(k)],$$

$$i \in \{S, R_1, R_2\}, \quad (1)$$

are mapped by \mathcal{M} to non-gray QPSK symbols, which follows the mapping rule $00 \rightarrow (+j)/\sqrt{2}$, $01 \rightarrow (-j)/\sqrt{2}$, $10 \rightarrow (1-j)/\sqrt{2}$, $11 \rightarrow (-1-j)/\sqrt{2}$, where $j = \sqrt{-1}$. The complex signal then transmitted over frequency-flat block Rayleigh fading channel with the complex channel gain $h_b, b \in \{SR_1, SR_2, R_1D, R_2D\}$. The transmitted signal having N symbols is denoted by

$$\mathbf{x}_i^m = [x_i^m(1), x_i^m(2), \dots, x_i^m(N)]^T \in \mathbb{C}^{N \times 1}. \quad (2)$$

2.2 Receive Phase

The received signal at node g can be formulated as

$$\mathbf{y}_g^m = h_{ig} \mathbf{x}_i^m + \mathbf{v}_g^m \in \mathbb{C}^{N \times 1}, g \in \{R_1, R_2, D\}, \quad (3)$$

where \mathbf{v} is a zero mean complex additive white Gaussian noise (AWGN) vector with variance σ^2 (double sided). The average signal-to-noise power ratio (SNR) is $\langle |h_{ig}|^2 \rangle / \sigma^2$ since $E[x_i^m] = 1$. With the help of *a priori* non-systematic information $L_{a, M^{-1}}^{c, m}$ provided by DEC_m , the demapper \mathcal{M}^{-1} calculates the extrinsic LLR $L_{e, M^{-1}}^{c, m}$ of the bit $q_g^m[v]$ from y_g^m by

$$L_{e, M^{-1}}^{c, m}(q_g^m[v]) = \ln \frac{P(q_g^m[v] = 1 | y_g^m)}{P(q_g^m[v] = 0 | y_g^m)}$$

$$= \ln \frac{\sum_{x \in x_1} \exp\left\{-\frac{|y_g^m - h_{ig} x_1|^2}{\sigma^2}\right\} \prod_{w=1, w \neq v}^k \exp\{-q_g^m[w] L_{a, M^{-1}}^{c, m}(q_g^m[w])\}}{\sum_{x \in x_0} \exp\left\{-\frac{|y_g^m - h_{ig} x_0|^2}{\sigma^2}\right\} \prod_{w=1, w \neq v}^k \exp\{-q_g^m[w] L_{a, M^{-1}}^{c, m}(q_g^m[w])\}}, \quad (4)$$

where x_0 and x_1 denote the sets of mapping pattern having the w -th bit being 0 and 1, respectively.

² DA is a rate-1 systematic recursive convolutional code where every ρ -th systematic bits is replaced with the accumulated coded bits [13].

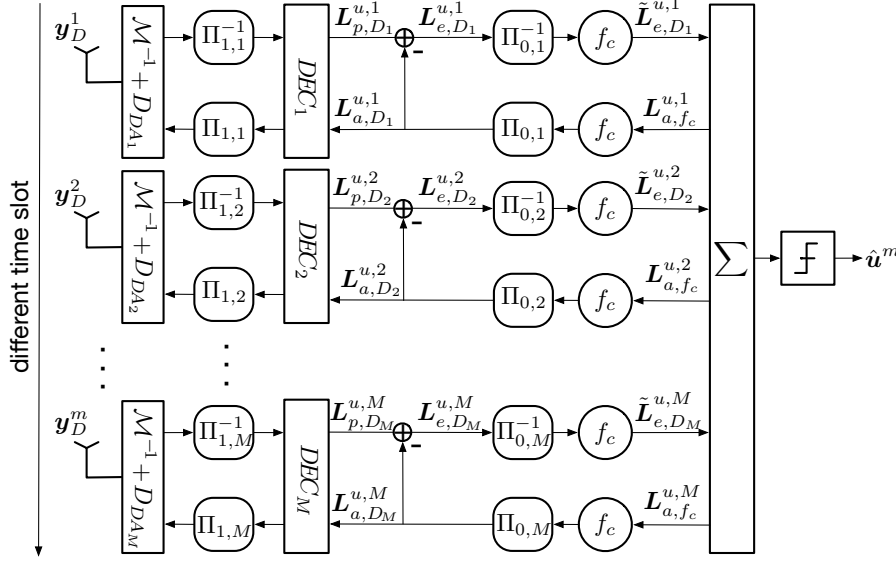

Fig. 4 Block diagram of the destination node.

The soft output vector of the demapper, $L_{e,M-1}^{c,m}$, is input to the DA_m decoder ($D_{DA,m}$), and its output extrinsic LLR is forwarded to the inner-deinterleaver prior to the channel decoder DEC_m . In PLF-HARQ scheme, the CI of the received packet is calculated, which is equivalent to the mutual information (MI) between the *a posteriori* LLR and the uncoded systematic-bits. The CI can be calculated online, as described in Section 3.

The structure of the destination node is shown in Fig. 4. The block diagram only shows the structure for receiving the packet sent from the relay node on the same link. However, the decoding process for the packet coming from the relay on the other link is the same. The combiner Σ combines all the *extrinsic* LLRs which are the outputs of all the channel decoders involved until the current stage of the HARQ round, not only over the parallel links but also retransmissions, as described above.

When the retransmitted packet is received, the *HI* is performed independently as in the first transmission. Then, the obtained *extrinsic* LLRs of the systematic information bits, $L_{e,D_m}^{u,m}$, are propagated crosswise between the soft-input soft-output (SISO) channel decoders via the combiner, as depicted in Fig. 4, of which process is referred to as vertical iteration (*VI*). *VI* can be seen as iterative decoding process of parallel concatenated code, which performs the equivalent role to "combining-after-decoding" [14]. After sufficient rounds of iterative *HI-VI-HI-VI* decoding processes, the final hard decisions to obtain \hat{u}^m is made on the *a posteriori* LLR of the information bits. CRC can be employed for packet error detection at this final stage only. If CRC detects error(s) decoded packet, it is saved in order to combine with the packet(s) to be transmitted in the following slots, within one full HARQ round.

At the destination node, the *extrinsic* systematic LLRs $L_{e,D_m}^{u,m}$ are updated by the function f_c , defined by (6). The function f_c is utilized to help the decoder eliminate the errors in the packets received by the relays, by exploiting the correlation knowledge between the information sequence obtained as the results of decoding at the relays. The correlation is indicated by the error probability p_e of the first hop, block-by-block. In this paper we assume

that p_e is known to the destination for the simplicity, even though it can be estimated by using the *a posteriori* LLRs, $L_{p,D_m}^{u,m}(R_1)$ and $L_{p,D_m}^{u,m}(R_2)$, the *a posteriori* LLR values of the uncoded (systematic) bits output from the decoders DEC_m of R_1 and R_2 , respectively, as presented in [16]. The updated *extrinsic* LLR of $L_{e,D_m}^{u,m}$ at each relay node can then be obtained by [13]

$$\tilde{L}_{e,D_m}^{u,m} = f_c(\bar{L}_{e,D_m}^{u,m}, \hat{p}_e) \quad (5)$$

$$= \ln \frac{(1 - \hat{p}_e) \cdot \exp(\bar{L}_{e,D_m}^{u,m}) + \hat{p}_e}{(1 - \hat{p}_e) + \exp(\bar{L}_{e,D_m}^{u,m}) \cdot \hat{p}_e}, \quad (6)$$

where $\bar{L}_{e,D_m}^{u,m} = \Pi_{0,m}^{-1}(L_{e,D_m}^{u,m})$. The *a priori* LLR $L_{a,f_c}^{u,m}$ is then

$$L_{a,f_c}^{u,m} = \sum_{q \in \omega \setminus m} \tilde{L}_{e,D_m}^{u,m}, \quad (7)$$

with $\omega = \{1, 2, \dots, M\}$ being the set of the retransmission number.

3 Lossy-Forwarding HARQ Mechanism

Algorithm 1 Fully Lossy Forwarding HARQ

```

1: procedure FLF-HARQ
2:    $\mathcal{T} \leftarrow$  number of packets of message  $\mathcal{X}$ 
3:    $M \leftarrow$  maximum number of transmission per packet
4:    $t = (1, 2, 3, \dots, \mathcal{T})$ 
5:    $m = (1, 2, 3, \dots, M)$ 
6:   Initialize  $t \leftarrow 1$ 
7:   for each packet  $\mathcal{X}(t)$  do
8:     Initialize  $m \leftarrow 0$ 
9:      $S$  broadcast packet  $\mathcal{X}(t)$ 
10:     $m \leftarrow m + 1$ 
11:     $\tilde{\mathcal{X}}(t)_I \leftarrow$  decoded  $\mathcal{X}(t)$  at relay  $R_I$ 
12:     $R_I$  forward  $\tilde{\mathcal{X}}(t)_I$  to  $D$ 
13:    if  $\mathcal{X}(t)$  unrecovered at  $D$  and  $m \neq M$  then back to 9
14:    end if
15:     $t \leftarrow t + 1$ 
16:  end for
17: end procedure

```

In this section, we explain the mechanism of the proposed HARQ techniques. For FLF-HARQ, the relays always transmit the received packets regardless of whether the error is detected or not. It is an extension of the technique presented in [13] with no direct link between the source node and the destination node. The mechanism is illustrated in Table Algorithm 1.

On the other hand, for PLF-HARQ, the forwarding mechanism is depending on the CI value, where its mechanism is illustrated in Table Algorithm 2. At the very beginning of each HARQ rounds for multiple information sequences to be transmitted, the packet from the source node is forwarded to the destination node through the relay(s) even though it still contains errors. It is due to the CI threshold not set yet. The CI values are start calculated in order to be used when deciding either requesting retransmission or forwarding the packet.

Algorithm 2 Partially Lossy Forwarding HARQ

```

1: procedure PLF-HARQ
2:    $\mathcal{T} \leftarrow$  number of packets of message  $\mathcal{X}$ 
3:    $M \leftarrow$  maximum number of transmission per packet
4:    $t = (1, 2, 3, \dots, \mathcal{T})$ 
5:    $m_{SR} = (0, 1, 2, \dots, M)$ 
6:    $m_{R_I D} = (0, 1, 2, \dots, M)$ 
7:   Initialize  $t \leftarrow 1$ 
8:   for each packet  $\mathcal{X}(t)$  do
9:     Initialize  $m_{SR} \leftarrow 0$ ,  $m_{R_I D} \leftarrow 0$ 
10:     $S$  broadcast packet  $\mathcal{X}(t)$ 
11:     $m_{SR} \leftarrow m_{SR} + 1$ 
12:     $\alpha_{SR_I}^{m_{SR}} \leftarrow$  calculated CI at relay  $R_I$ , by (8)
13:    if  $m_{SR} = 1$  then
14:       $\alpha_{SR_I}^{m_{SR}-1} \leftarrow \alpha_{SR_I}^{m_{SR}}$ 
15:    else
16:      if  $R_I$  received NACK_2 for  $m_{SR} - 1$  and  $\alpha_{SR_I}^{m_{SR}-1} < \alpha_{SR_I}^{m_{SR}}$  then
17:         $\alpha_{SR_I}^{m_{SR}-1} \leftarrow \alpha_{SR_I}^{m_{SR}}$ 
18:      end if
19:    end if
20:    if  $R_I$  received NACK_2 for  $m_{SR} - 1$  and  $\alpha_{SR_I}^{m_{SR}-1} \geq \alpha_{SR_I}^{m_{SR}}$  then
21:       $R_I$  send NACK_1 to  $S$ 
22:      back to 10
23:    end if
24:     $\tilde{\mathcal{X}}(t)_I \leftarrow$  decoded  $\mathcal{X}(t)$  at relay  $R_I$ 
25:     $R_I$  forward  $\tilde{\mathcal{X}}(t)_I$  to  $D$ 
26:     $m_{R_I D} \leftarrow m_{R_I D} + 1$ 
27:     $\alpha_{R_I D}^{m_{R_I D}} \leftarrow$  calculated CI, before joint decoding, at  $D$ , by (8)
28:    if  $m_{SR} = 1$  and  $m_{R_I D} = 1$  then
29:       $\alpha_{R_I D}^{m_{R_I D}-1} \leftarrow \alpha_{R_I D}^{m_{R_I D}}$ 
30:    else
31:      if  $\mathcal{X}(t)$  unrecovered for  $m_{R_I D} - 1$  and  $\alpha_{R_I D}^{m_{R_I D}-1} < \alpha_{R_I D}^{m_{R_I D}}$  and  $m_{R_I D} \neq M$  and  $m_{SR} \neq M$  then
32:         $\alpha_{R_I D}^{m_{R_I D}-1} \leftarrow \alpha_{R_I D}^{m_{R_I D}}$ 
33:      end if
34:    end if
35:    if  $\mathcal{X}(t)$  unrecovered from  $\tilde{\mathcal{X}}(t)_I$  at  $D$  and  $m_{R_I D} = 1$  then
36:       $D$  send NACK_1 to  $R_I$ 
37:      back to 25
38:    else if  $\mathcal{X}(t)$  unrecovered from  $\tilde{\mathcal{X}}(t)_I$  at  $D$  and  $m_{R_I D} \neq M$  and  $m_{SR} \neq M$  then
39:       $D$  send NACK_2 via  $R_I$ 
40:      back to 10
41:    else
42:       $t \leftarrow t + 1$ 
43:    end if
44:  end for
45: end procedure

```

It is an online calculation technique for the MI between the *a posteriori* LLR output of the channel decoder and the information sequence from the previous node [17], as

$$CI = 1 - \frac{1}{N} \sum_{n=1}^N H_b\left(\frac{1}{1 + e^{-|L_n|}}\right), \quad (8)$$

where $H_b(\cdot)$ is a binary entropy function. The CI calculation is beneficial since the receiving nodes do not need to know the original information sequence. The probability of error corresponding to the CI value can be calculated by

$$P_b \approx \frac{1}{2} \operatorname{erfc}\left(\frac{J^{-1}(CI)}{2\sqrt{2}}\right), \quad (9)$$

where $J^{-1}(\cdot)$ is the inverse of function $J(\cdot)$ [18]. It is worth noting that P_b is the error corresponds to the BER per link.

The receiving nodes send a negative acknowledgement (NACK) to their previous node to indicate unsuccessful decoding and hence requesting retransmission. There are two types of NACK in PLF-HARQ: NACK_1 indicating a retransmission required from the node in the one-hop back, and NACK_2 indicating retransmission required from the node in the two-hop back. Therefore, if a transmitting node receives NACK_1, it will retransmit the packet to the next node. On the other hand, if a transmitting node receives NACK_2, it will transmit NACK_1 to the previous node.

The destination node evaluates CI values of packets transmitted from all links, before packet combining. The destination node transmits NACK_1 whenever the packets transmitted for the first time (not retransmitted version) by the relay are unsuccessfully recovered. This is to avoid the excessive end-to-end latency. In this case, the CI is used as the threshold. Additionally, the destination node transmits NACK_2 whenever the have-retransmitted packets are unsuccessfully recovered. In this case, the destination node uses the CI value, which is larger than the previous CI as the threshold. As for the relay node, the threshold is set equal to CI of the very beginning of the HARQ rounds and update it whenever receiving NACK_2.

4 EXIT Analysis in Static AWGN Channel

Even though the channel assumption this paper made is block Rayleigh fading, link-by-link as well as transmission-by-transmission, evaluating the convergence property of the proposed signal detection and decoding technique in static AWGN channel provides us with an in-depth understanding of the behavior of the decoder. Therefore, in this section, we evaluate the convergence property of the proposed lossy forwarding schemes by utilizing the EXIT chart analysis.

Fig. 5 shows the EXIT curves of \mathcal{M}^{-1} using QPSK with Gray and non-Gray mapping, assuming the receive SNR being 6 dB, for comparison. It is found that with Gray mapping, the EXIT curve is entirely flat regardless of the *a priori* information. It means that the feedback from DEC does not help \mathcal{M}^{-1} to improve performance through the iterative process. On the other hand, by using non-Gray mapping, the EXIT curve rises up as the given *a priori* information increases, but still, it can not reach a point close enough to (1.0,1.0) MI point. The extrinsic MI exchange between the $\mathcal{M}^{-1} + D_{DA_m}$ and DEC_m is evaluated. The structure of Turbo HARQ technique enables the use of different ρ of the DA transmission-by-transmission to achieve better matching of the EXIT curves. The ρ^m value is determined

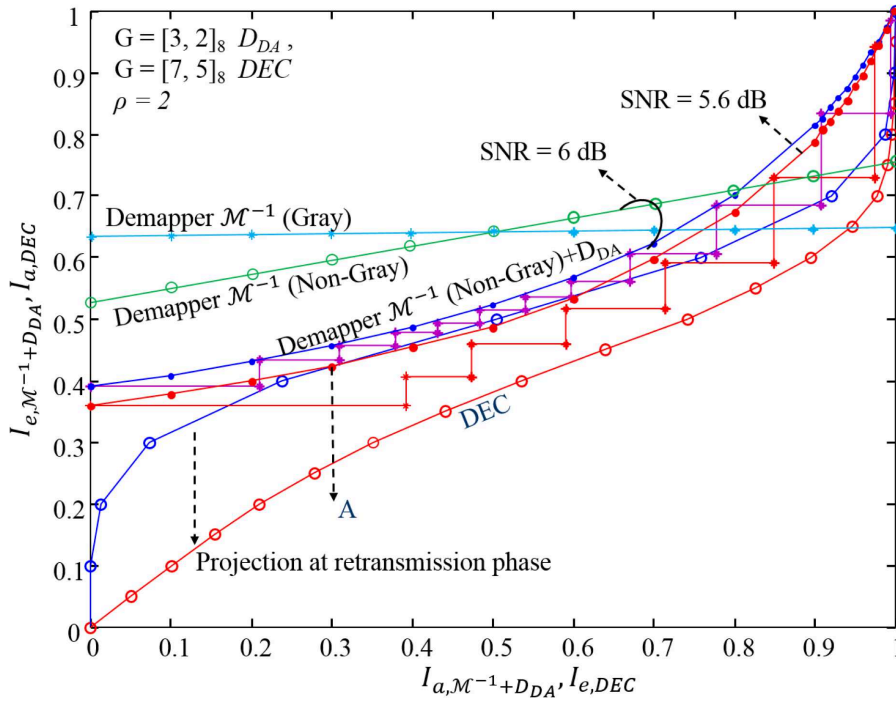

Fig. 5 EXIT Chart of Demapper+ D_{DA} for single snapshot of channel realization and DEC.

by evaluating the EXIT curves of inner and outer codes so that they are best matched with the all possible values of the ρ s while keeping the convergence tunnel open. With a proper setting of code parameters, no retransmission is required if its received SNR is larger than the threshold at which the convergence tunnel opens.

Suppose that the destination node combines the two received packets, the original transmission, and its subsequent first retransmission. Fig. 5 shows the EXIT curve where D_{DA} uses a generator $[3, 2]_8$ non-systematic non-recursive convolutional code (NSNRCC), and DEC uses a generator $[7, 5]_8$ NSNRCC. The figure also shows the trajectory of the MI exchange with the maximum iteration of 350. We set the interleaver length to 10,000. The DEC's EXIT curve is obtained after the one round of HI-VI from the two different decoders for (re)transmitted packets until no relevant improvement in MI between \mathbf{u} and $\mathbf{L}_{a, DEC}^u$ is achieved.³

We set the doping rate $\rho = 2$ for the two transmissions, and the instantaneous SNR is kept at 6 dB. It is found that the $\mathcal{M}^{-1}+D_{DA_m}$ makes the convergence tunnel open until a point very close to the (1.0, 1.0) MI point. This means that no retransmission is needed. When SNR is 5.6 dB, the $\mathcal{M}^{-1}+D_{DA_m}$ curve intersects at the point "A". However, this problem can be solved with the help of VI that pushes down the decoder curve, resulting in better matching between Demapper+ D_{DA} and DEC curves. Moreover, the gap between the two curves can further be reduced by adjusting the doping rate [14].

³ In this sense, the EXIT Chart analysis provided in this section is based on [19] projection technique.

5 Numerical Results

We evaluate average end-to-end PER, BER, and throughput performances by computer simulations that consider the transmission of 100,000 packets with the size of 10,000 bits per packet. The maximum number of retransmissions per node is set to 4 ($M = 5$). All nodes use the same channel coding, where a half-rate NSNRCC with a generator polynomial $G = [7, 5]$ is considered. They all also use the same varying doping ratio ρ (re)transmission-by-(re)transmission, where $\rho \in \{2, 10, 15, 20, 25\}$.

We assume no processing time restriction for the overall transmission of information from the source to the destination nodes, and hence the relay nodes can decode the packet before they forward. We also assume an ideal medium access control protocol, where each node can transmit and receive a packet independently. Each node is allowed to transmit and receive only one packet simultaneously, and every packet transmitted from the nodes is received without collisions.

We compare PLF-HARQ and FLF-HARQ with the conventional schemes as shown in [12], which are SHARQ I and SHARQ II. In the conventional schemes, either Relay 1 or Relay 2, or both relays forward error-free packets only. If the destination node fails in recovering the packet, SHARQ I performs retransmission from the relay node(s), whereas SHARQ II performs retransmission from the source node. In FLF-HARQ scheme, the relay nodes always forward any received packets, and therefore the receiving nodes do not need to calculate the CI. We set no packet combining at the relay nodes for all schemes.

Figs. 6 and 7 show that PLF-HARQ outperforms the conventional schemes and FLF-HARQ in terms of average end-to-end BER and PER performances, respectively. The theoretical lower bound is shown in Fig. 7 as a reference to confirm the performances of PLF-HARQ and FLF-HARQ.⁴ The lower bound is calculated based on the outage probability of CAD technique [14] for $M = 10$ as

$$P_{out} = \Pr(\mathcal{R} > C_A), \quad (10)$$

$$C_A = M \log_2 \left(1 + \frac{1}{M} \sum_{m=1}^M \frac{\gamma_m}{M} \right), \quad (11)$$

where \mathcal{R} , C_A , and γ_m are the transmission rate, the capacity of the CAD, and the instantaneous SNR of the m -th transmission, respectively. The gap of 18 dB between the PLF-HARQ and the lower bound is reasonable because it is a lower bound assuming that all packets transmitted by the relays have no errors. The conventional scheme fails to combine all transmitted packet to achieve more diversity gain as achieved by PLF-HARQ and FLF-HARQ. Furthermore, PLF-HARQ can achieve the coding gain compared to FLF-HARQ as shown by the parallel shift in Fig. 7, because of its ability to carefully combine the most reliable packets by employing the CI.

We define the average end-to-end throughput performance η as

$$\eta = \frac{\text{average number of correctly decoded packets at destination node}}{\text{number of transmitted packets by source node}} \cdot \frac{1}{\text{number of used time slots}}. \quad (12)$$

We normalized the throughput over two-time slots, which means that the throughput of one is achieved whenever a packet is successfully recovered within two-time slots. Intuitively it is easy to understand the packet-based transmission performance by the packet loss, and

⁴ The theoretical bound for BER is not shown in Fig. 6 because it is difficult to calculate since the coding structure should be considered.

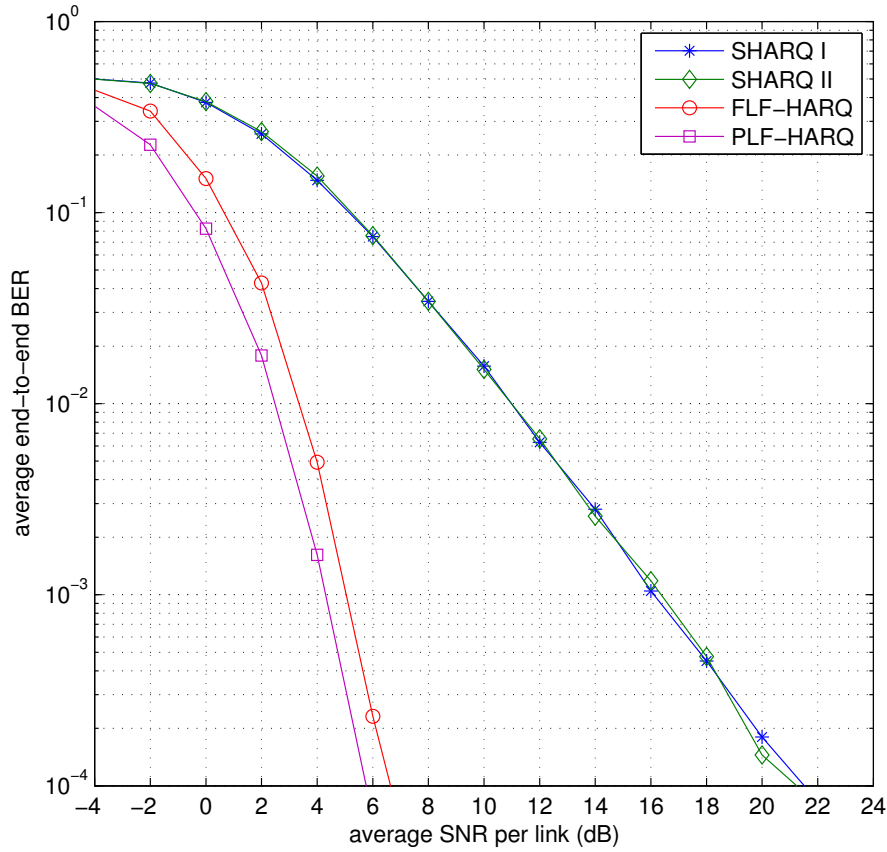

Fig. 6 Average end-to-end BER performances.

hence we define the average end-to-end packet loss ratio δ from (12) as the average number of unrecoverable packets at the destination per time slot over the number transmitted packets by the source node, or given by

$$\delta = 1 - \eta. \quad (13)$$

Fig. 8 shows the performances of average end-to-end throughput versus the average end-to-end BER for the proposed FLF-HARQ and PLF-HARQ as well as the conventional SHARQ I, II techniques for comparison. Obviously, the proposed techniques outperform the conventional SHARQ I and II techniques. It is found that in the high δ (low throughput value) range, the BER performance of FLF-HARQ is lower than PLF-HARQ. However, when $\delta < 60\%$, the BER performance with PLF-HARQ gradually decreases. When the end-to-end packet loss ratio is 55% in average, the average end-to-end BER with PLF-HARQ is 0.00035, but 0.00063 with FLF-HARQ, 0.11500 with SHARQ I, and 0.09200 with SHARQ II. The gap between the FLF-HARQ and PLF-HARQ is expected to be gradually larger for the lower packet loss ratio. Hence, FLF-HARQ is suitable for the packet-loss tolerant systems whereas PLF-HARQ is preferable for the systems requiring very low packet loss ratio.

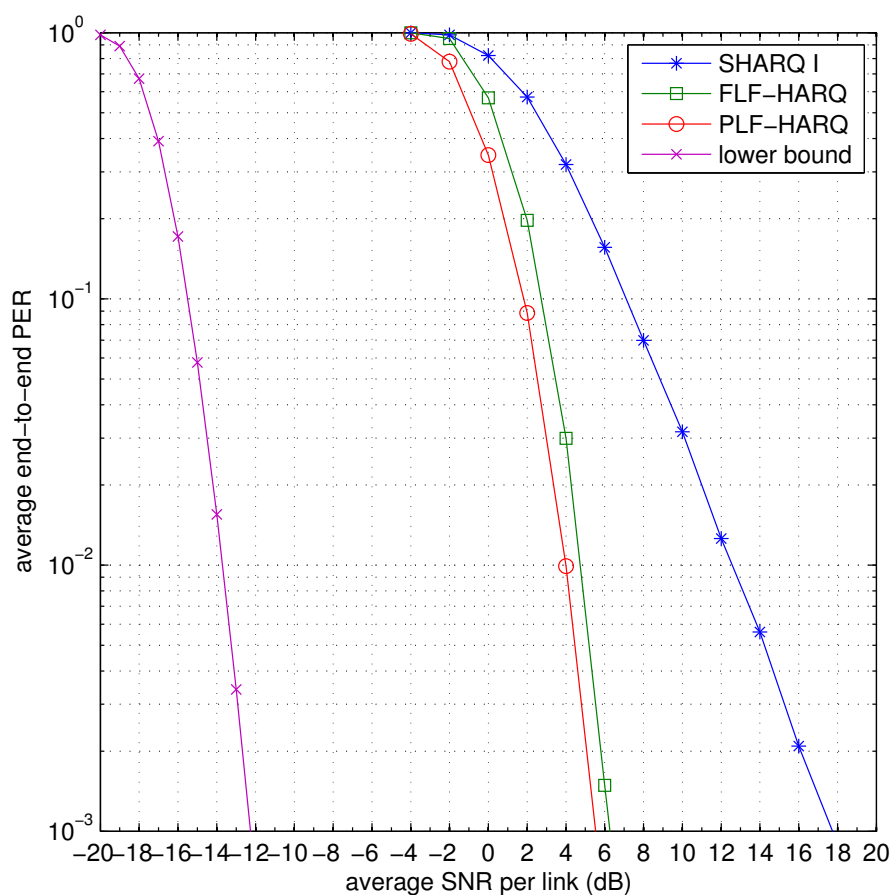

Fig. 7 Average end-to-end PER performances.

6 Conclusion

Partially and Fully Lossy-Forwarding HARQ schemes have been proposed to improve the system throughput of parallel relay networks. The improvement is obtained by (i) exploiting the correlation among received packets at the destination node, and (ii) allowing lossy forwarding at the relay. Results of computer simulations verified the significant improvement on BER, PER and throughput performances over frequency-flat block Rayleigh fading channels. These results are relevant for future networks covering long range communication having high throughput with low power consumption.

Acknowledgements This work has been performed in the framework of the FP7 project ICT-619555 RES-CUE (Links-on-the-fly Technology for Robust, Efficient and Smart Communication in Unpredictable Environments) which is partly funded by the European Union.

This work has been also supported in part under JSPS Kakenhi Grant Number 26289119.

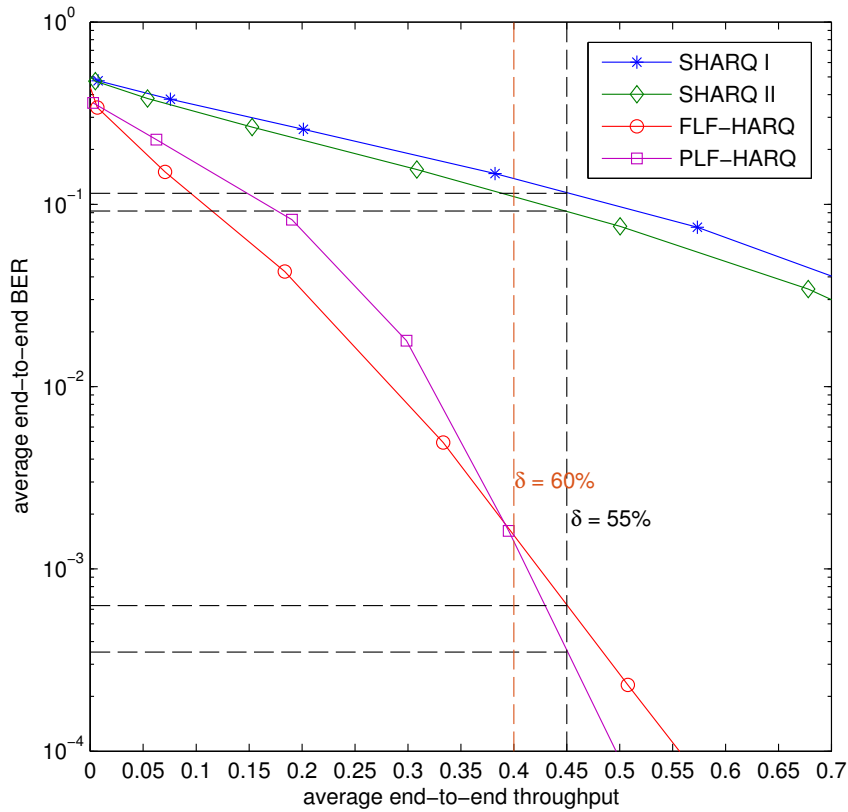

Fig. 8 Average end-to-end throughput performances correspond to the average end-to-end BER performances.

References

1. Wu, H., Qiao, C., De, S., Tonguz, O.: Integrated cellular and Ad Hoc relaying systems: iCAR. *Selected Areas in Communications, IEEE Journal on* **19**(10), 2105–2115 (2001)
2. Li, Y., Rahman, M., Ng, S.X., Vucetic, B.: Distributed soft coding with a soft input soft output (SISO) relay encoder in parallel relay channels. *Communications, IEEE Transactions on* **61**(9), 3660–3672 (2013)
3. Wiemann, H., Meyer, M., Ludwig, R., O, C.P.: A novel multi-hop ARQ concept. In: *Vehicular Technology Conference, 2005. VTC 2005-Spring, 2005 IEEE 61st*, pp. 3097–3101 (2005)
4. Jeon, S.Y., Han, K.Y., Suh, K., Cho, D.H.: An efficient ARQ mechanism in multi-hop relay systems based on IEEE 802.16 OFDMA. In: *Vehicular Technology Conference, 2007. VTC-2007 Fall, 2007 IEEE 66th*, pp. 1649–1653 (2007)
5. Jeon, S.Y., Cho, D.H.: Modelling and analysis of ARQ mechanisms for wireless multi-hop relay system. In: *Vehicular Technology Conference, 2008. VTC Spring 2008. IEEE*, pp. 2436–2440 (2008)
6. Tabet, T., Dusad, S., Knopp, R.: Achievable diversity-multiplexing-delay tradeoff in half-duplex ARQ relay channels. In: *Information Theory, 2005. ISIT 2005. Proceedings. International Symposium on*, pp. 1828–1832 (2005)
7. Chiarotto, D., Simeone, O., Zorzi, M.: Throughput and energy efficiency of opportunistic routing with Type-I HARQ in linear multihop networks. In: *Global Telecommunications Conference (GLOBECOM 2010), 2010 IEEE*, pp. 1–6 (2010)

8. Fu, W., Tao, Z., Zhang, J., Agrawal, D.: Error control strategies for WiMAX multi-hop relay networks. In: Global Telecommunications Conference, 2009. GLOBECOM 2009. IEEE, pp. 1–6 (2009)
9. Kim, S.H., Jung, B.C.: On the optimal link adaptation in linear relay networks with incremental redundancy HARQ. *Communications Letters, IEEE* **18**(8), 1411–1414 (2014)
10. Levorato, M., Librino, F., Zorzi, M.: Integrated cooperative opportunistic packet forwarding and distributed error control in MIMO Ad Hoc networks. *Communications, IEEE Transactions on* **59**(8), 2215–2227 (2011)
11. Zhao, B., Valenti, M.: Practical relay networks: a generalization of hybrid-ARQ. *Selected Areas in Communications, IEEE Journal on* **23**(1), 7–18 (2005)
12. Bhamri, A., Kaltenberger, F., Knopp, R., Hamalainen, J.: Smart Hybrid-ARQ (SHARQ) for cooperative communication via distributed relays in LTE-Advanced. In: *Signal Processing Advances in Wireless Communications (SPAWC), 2011 IEEE 12th International Workshop on*, pp. 41–45 (2011)
13. Anwar, K., Matsumoto, T.: Accumulator-assisted distributed turbo codes for relay systems exploiting source-relay correlation. *Communications Letters, IEEE* **16**(7), 1114–1117 (2012)
14. Irawan, A., Anwar, K., Matsumoto, T.: Combining-after-decoding turbo hybrid ARQ by utilizing doped-accumulator. *IEEE Commun. Letters* **17**(6), 1212–1215 (2013)
15. Irawan, A., Anwar, K., Matsumoto, T.: Lossy forwarding technique for parallel multihop-multirelay systems. In: *Vehicular Technology Conference (VTC Fall), 2015 IEEE 82nd*, pp. 1–5 (2015)
16. Wolf, A., Matthe, M., Fettweis, G.: Improved source correlation estimation in wireless sensor networks. In: *IEEE ICC 2015-Workshop on Advanced PHY and MAC Technique for Super Dense Wireless Networks (2015)*
17. Hagenauer, J.: The EXIT chart - introduction to extrinsic information transfer in iterative processing. *European Signal Processing Conference* p. 1541–1548 (2004)
18. Ten Brink, S.: Convergence behavior of iteratively decoded parallel concatenated codes. *Communications, IEEE Transactions on* **49**(10), 1727–1737 (2001)
19. Irawan, A., Anwar, K., Matsumoto, T.: Low complexity time concatenated turbo equalization for block transmission without guard interval: Part 3–application to multiuser SIMO-OFDM. *Wireless personal communications* **70**(2), 769–783 (2013)