

Title	System-level performance evaluation of MMSE MIMO turbo equalization techniques using measurement data
Author(s)	Sarestoniemi, Mariella; Matsumoto, Tad; Schneider, Christian; Thoma, Reiner
Citation	Proceedings of the 14th European Signal Processing Conference (EUSIPCO 2006)
Issue Date	2006-09
Type	Conference Paper
Text version	publisher
URL	http://hdl.handle.net/10119/9116
Rights	Copyright (C) 2006 EURASIP. Mariella Sarestoniemi, Tad Matsumoto, Christian Schneider, and Reiner Thoma, Proceedings of the 14th European Signal Processing Conference (EUSIPCO 2006), 2006.
Description	14th European Signal Processing Conference (EUSIPCO 2006), Florence, Italy, September 4-8, 2006

SYSTEM-LEVEL PERFORMANCE EVALUATION OF MMSE MIMO TURBO EQUALIZATION TECHNIQUES USING MEASUREMENT DATA

Mariella Särestöniemi*, Tad Matsumoto***, Christian Schneider**, and Reiner Thomä**

* University of Oulu

P.O. Box 4500, 90014 University of Oulu, Finland
phone: + (358) 40 58 22 935, email: mariella@ee.oulu.fi

**Ilmenau University of Technology, Electronic Measurement Research Lab.

PSF 100 565, D-98684 Ilmenau, Germany
emails: firstname.surname@tu-ilmenau.de

ABSTRACT

In this paper, system-level performance of three different MMSE turbo MIMO equalization techniques is evaluated in realistic scenarios. Soft cancellation and minimum mean squared error filtering (SC/MMSE) turbo equalization and its complexity reduced version, turbo equalized diversity, is considered. Furthermore, another version of equalized diversity, turbo equalized diversity with common SC/MMSE, which exploits the transmit diversity and coding gain through the cross-wise iterations over the decoding branches, is evaluated. The multi-dimensional channel sounding measurement data used for the simulations consists of snapshots measured in different channel conditions in terms of spatial and temporal properties. The system-level assessment is in terms of outage probabilities of the performance figures such as bit and frame error rates obtained by evaluating their cumulative probability densities as well as throughput efficiencies using the field measurement data. It is found that the receivers considered in this paper can all provide reasonable system-level performance. However, turbo equalized diversity receiver is more sensitive to the channel conditions than the original SC/MMSE equalizer. It is also found that the performance gain, obtained from the cross-wise iteration over the decoding branches in the turbo equalized diversity with common SC/MMSE technique, is significant.

1. INTRODUCTION

In broadband single carrier signalling, the receiver has to efficiently suppress the effects of interferences, such as inter-symbol-interference (ISI) and multiple-access-interference (MAI). A promising detection technique, which can meet this requirement without requiring prohibitively high complexity, is a soft cancellation and minimum mean squared error filtering (SC/MMSE) based turbo equalization [1], [2]. The SC/MMSE turbo equalizer has been shown to achieve almost equivalent performance to the optimal detector based on maximum likelihood sequence estimator (MLSE) but it requires only a complexity order $O(L^3M^3)$, with L and M being the number of propagation paths and receive antennas, respectively. SC/MMSE's complexity can be further reduced using approximation techniques [3],[4], turbo equalized diversity technique [5], and frequency domain signal processing [6].

The SC/MMSE turbo equalization was first extended to multiple-input multiple-output (MIMO) systems in [7]. Since then, SC/MMSE MIMO turbo equalization has been studied intensively and its performance has been verified also in realistic scenarios using channel measurement data [8] [9] [10].

The primary purpose of this paper is to evaluate the in-field performance of MMSE MIMO turbo equalization techniques using multi-dimensional channel sounding field measurement data. Single user as well as multiuser cases are considered. The major objective is to make system-level assessments for the techniques investi-

gated in this paper in terms of outage probabilities of performance figures such as bit and frame error rate obtained by evaluating their cumulative probabilities in the measurement area. Furthermore, receivers' average throughput efficiencies are examined when selective-repeat automatic repeat request (ARQ) is assumed.

This paper is organized as follows: Section 2 describes the signal model. Section 3 presents the MIMO turbo equalization techniques evaluated in this paper. In Section 4, channel characteristics obtained by analyzing the measurement data are presented and performance simulation results are shown. The paper is summarized in Section 5.

2. SIGNAL MODEL

2.1 Transmit schemes

In this paper, two different transmission schemes are considered depending on the turbo equalization technique used in the receiver. In the first scheme, the information data bits are divided into N transmit branches in which the encoding, interleaving and modulation are performed separately. Obviously, this configuration is spatial multiplexing, and it aims to enhance data rate without increasing the symbol rate. The second scheme exploits the principle of the transmit diversity where the same information data is fed to N transmit branches in which the encoding, interleaving and modulation are performed separately.

2.2 Received signal

First, single user MIMO case is considered. The signals transmitted from N antennas suffer from frequency selective fading due to multipath propagation. The receiver has M antennas. A discrete time representation of the received signal at the m th receive antenna is

$$r_m(k) = \sum_{l=0}^{L-1} \sum_{n=1}^N h_{mn}(l)b_n(k-l) + v_{mn}(k), \quad (1)$$

where $b_n(k)$ is the encoded bit transmitted from the n th transmit antennas at the k th symbol timing, $h_{mn}(l)$ is a discrete time representation of the channel between the n th transmitter and the m th receiver antenna and $v_{mn}(k)$ is additive white Gaussian noise (AWGN). Spatial and temporal signal sampling is performed to the received signal. The space-time representation of the received signal is then given by

$$\mathbf{y}(k) = \mathbf{H}\mathbf{u}(k) + \mathbf{V}(k), \quad (2)$$

where

$$\mathbf{H} = \begin{bmatrix} \mathbf{H}_{m1}(0) & \cdots & \mathbf{H}_{m1}(L-1) & & 0 \\ & \ddots & & \ddots & \\ 0 & & \mathbf{H}_{mN}(0) & \cdots & \mathbf{H}_{mN}(L-1) \end{bmatrix} \quad (3)$$

represents the temporal and spatial characteristics of the frequency selective MIMO channel. $\mathbf{u}(k)$ and $\mathbf{V}(k)$ are the transmitted symbols and noise components, respectively. The details of the signal model can be found e.g. in [1].

3. MMSE MIMO TURBO EQUALIZATION SCHEMES

3.1 Original SC/MMSE MIMO Turbo Equalizer

The original SC/MMSE MIMO turbo equalizer, evaluated in this paper, aims to achieve spatial multiplexing gain (first transmit scheme). Fig. 1 represents the transmitter-receiver block diagram of the original SC/MMSE MIMO turbo equalizer. The iterative receiver consists of two main parts: the common SC/MMSE part, which performs the cancellation of different interfering components, and independent soft-input soft-output (SfISfO) decoding for each user and each transmit branch.

The SC/MMSE part delivers log-likelihood ratios (LLR) of each symbol in a frame. After de-interleaving, the SfISfO decoding is performed. The updated LLRs are fed back to the SC/MMSE part, which performs the SC/MMSE processing again. This process is repeated until the convergence of the performance is achieved. The details of the SC/MMSE algorithm can be found in [1]-[2].

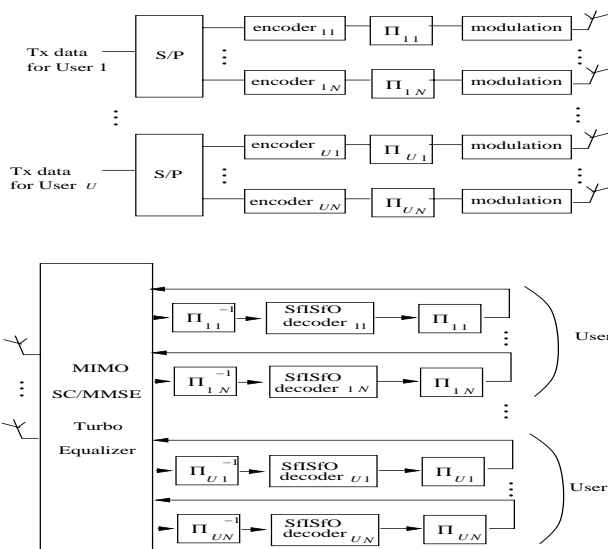

Fig. 1. The transmitter-receiver block diagram of the SC/MMSE MIMO turbo equalizer.

3.2. Turbo Equalized Diversity

The turbo equalized diversity was introduced in [5] to reduce the complexity of the SC/MMSE equalizer by splitting the multiple receiver antenna elements into diversity branches, in which the SC/MMSE signal processing is performed first separately. After the sufficient number of SC/MMSE iterations, the cross-wise iterations over the SfISfO decoders are performed. By using turbo equalized diversity, the complexity can be reduced to $O((L^3M^3)/K^2)$, where K is the number of diversity branches. [5]

The turbo equalized diversity receiver aims spatial multiplexing gain as well (the first transmit scheme). The block diagram of the SC/MMSE MIMO turbo equalized diversity receiver is shown in Fig. 2. For clarity of this figure, the receiver antenna elements are split into two SC/MMSE branches and a single user case is considered. The SC/MMSE equalizers and SfISfO decoders are connected via two sets of switches S_a and S_b . First, the SC/MMSE iterations take place independently in each of the branches, i.e. switches S_a are closed and S_b are open. This process is referred to as a *horizontal iteration*. After the convergence of horizontal iterations, S_a are opened and S_b are closed to enable the exchange of the LLRs between the decoders, which is referred to as a *vertical iteration*. Finally, the LLRs of the bits are combined, on which the final decision is made. The details of the turbo equalized diversity receiver algorithm can be found in [5].

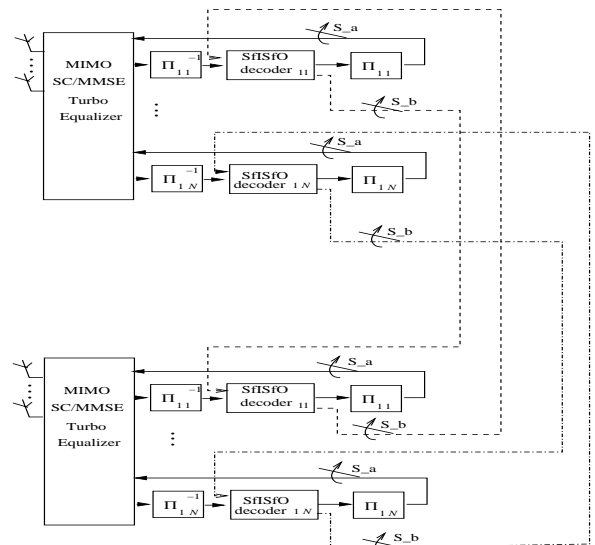

Fig. 2. Turbo equalized diversity receiver in the single user case as the diversity branch number K is 2.

3.3. Turbo Equalized Diversity with Common SC/MMSE

The turbo equalized diversity with common SC/MMSE receiver is introduced to exploit the transmit diversity gain (second transmit scheme), which also enables exploiting coding gain through the vertical iteration in the receiver between the decoder branches related to the same user.

A transmitter-receiver block diagram of the turbo equalized diversity with common SC/MMSE MIMO receiver is depicted in Fig. 3. Similarly to the turbo equalized diversity, there are two sets of switches S_a and S_b , by which horizontal and vertical iterations are controlled. During the horizontal iterations, S_a are closed and S_b open in order to enable pure SC/MMSE processing within each of the SfISfO decoder branch. After the convergence, S_a are opened and S_b closed for the vertical iterations during which the LLRs are exchanged between the decoding branches related to the same user. Finally, the LLRs of the bits are combined, on which the final decision is made.

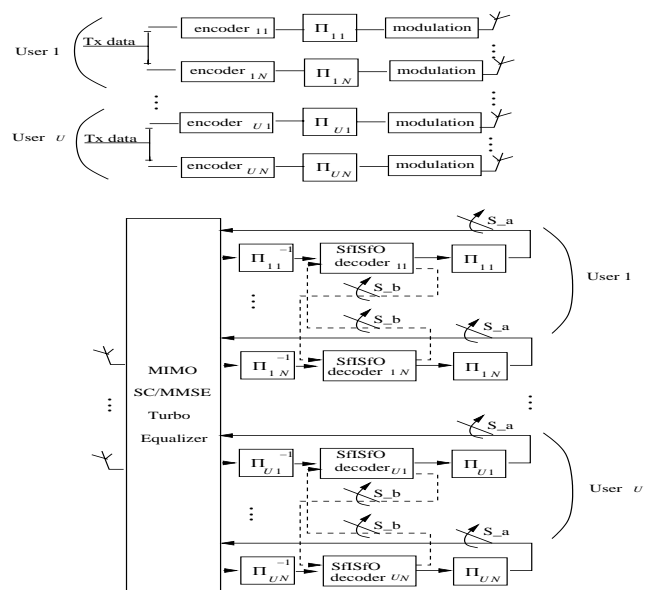

Fig. 3. The transmitter-receiver block diagram for the turbo equalized diversity with common SC/MMSE receiver.

4. PERFORMANCE EVALUATION

In this section, performance of the three MIMO turbo equalization schemes is evaluated using multi-dimensional channel measurement data which is released by MEDAV via the website [11]. The measurement data was collected in a courtyard at the campus of Technical University of Ilmenau, Germany. A map of the measurement route is shown in Fig. 4.

The first 3 meters of the measurement route is characterized by a non-line-of-sight (NLOS) part whereas the rest of the route has line-of-sight (LOS) condition. The total number of the measurement snapshots is 108. The first 16 snapshots correspond to the static NLOS condition (SNLOS) since the transmitter was held still. Snapshots 17-51 belong to the dynamic NLOS (DNLOS) region where the transmitter was moving along the NLOS part. The last snapshots (52-108) were measured when transmitter moved along the LOS region. These three regions have different propagation conditions, as can be noted from Fig. 5 [9], which presents direction of arrival (rms Rx azimuth) and direction of departure (rms Tx azimuth) spreads. Details of the measurement data and the propagation conditions can be found in [9].

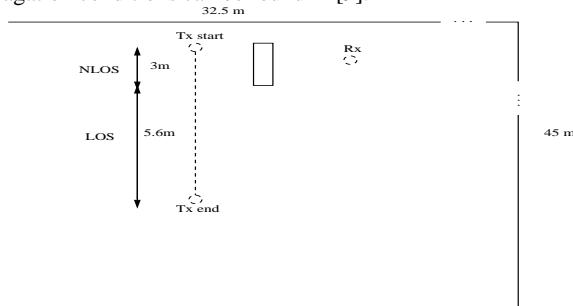

Fig. 4. The map of the measurement route.

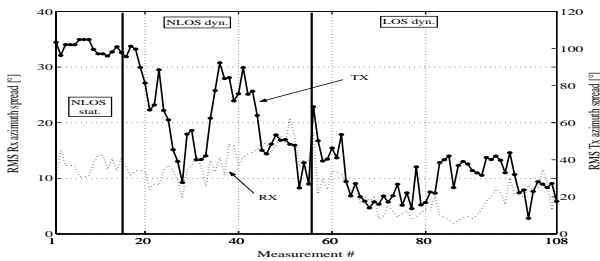

Fig. 5. RMS Rx and Tx azimuth spreads for the MIMO measurement route.

Performance of the three different SC/MMSE MIMO turbo equalizers is evaluated both in single user and multiuser cases. In the simulations, the $\frac{1}{2}$ code rate convolutional channel code with constraint length 3 is assumed. Binary phase shift keying (BPSK) is used as the modulation format. Channel estimation is assumed to be perfect. The pre-processed channel impulse responses were normalized to have unit mean energy for each transmitter and receiver antenna pairs. The rest of the simulation parameters are summarized in Table I.

Table I Simulation parameters

Interleaving	Random
Symbol rate	20 Msymb/s
Tx/ Rx antennas	2 / 4
Turbo diversity branch number	2
Iterations	Horizontal=4, vertical=1
Information bits	516

Single user case

First, performance was evaluated in all the 108 snapshots. In order to illustrate the performance dependency on the propagation

conditions, the frame-error-rate (FER) obtained in the measurement snapshots is shown in Fig. 6 for the original SC/MMSE MIMO turbo equalizer (solid line) and the turbo equalized diversity scheme (dashed line). For clarity of the figure, FER curves are smoothed by averaging over two consecutive snapshots. Signal-to-noise-ratio (SNR) is fixed at 5 dB. It is noted that the performance tendency is largely affected by the propagation conditions shown in Fig. 5: In the SNLOS region, where Tx and Rx azimuth spreads are relatively wide and the curves are smooth, FER for the both receivers is relatively low and at the same level within the whole region. Instead in the DNLOS region, propagation conditions vary significantly, and hence also FER changes significantly. For the both receivers, the FER is highest in the LOS region, where the azimuth spreads are clearly narrower than in the other regions. In all the three regions, the FER for the turbo equalized diversity is found to be higher than that for the original SC/MMSE. This is due to the splitting of the receive antennas into several turbo equalized diversity groups, which brings about a detrimental impact on the signal separability within each group.

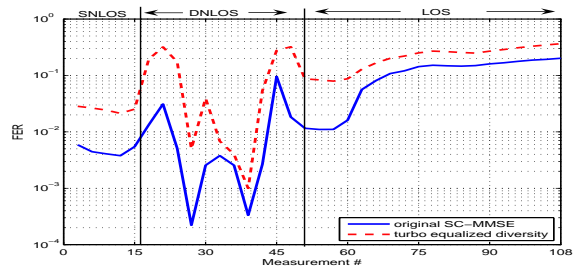

Fig. 6. FER of the original MIMO SC/MMSE equalizer and the turbo equalized diversity as SNR is 5dB.

Similarly, FER for the turbo equalized diversity with common SC/MMSE MIMO receiver after the vertical iteration is shown in Fig. 7 (dash-dot line). As a reference curve, FER without the vertical iteration (solid line) is included, which in fact corresponds to the FER of the original MIMO SC/MMSE when the second transmit scheme (described in Paragraph 2.1) is used. SNR is fixed at 3dB. The performance of the turbo equalized diversity with common SC/MMSE receiver is found to depend clearly on propagation conditions as well: FER is low in the snapshots related to wide azimuth spreads. The vertical iteration gain is noted to be remarkably high especially in the DNLOS region: There are several snapshots where no frame errors occurred in the simulations where 700 frames were transmitted. These snapshots correspond to the propagation condition with the highest RX azimuth spread. Instead, in the LOS regions there are snapshots where the vertical iteration gain is minor. These snapshots correspond to the propagation condition with the lowest azimuth spreads.

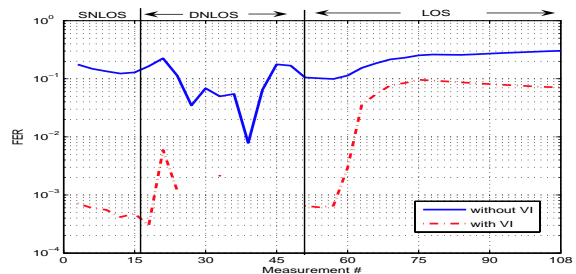

Fig. 7. FER of the turbo equalized diversity with common SC/MMSE receiver after the vertical iteration at SNR of 3dB.

In order to illustrate the variations of the performance figures and also make system-level assessments, CDF for FER and BER performances are presented as well as average throughput efficiency is examined. For the selective-repeat ARQ assumed in this paper, the throughput efficiency (TP) is given by [12, Ch. 15]

$$TP=R(1-F), \quad (4)$$

where R is the code rate and F is the number of frame errors.

The CDFs for the BER and FER of the original SC/MMSE MIMO equalizer and the MIMO turbo equalized diversity scheme are shown in Fig. 8a and Fig 8b, respectively. For clarity of the figure, CDFs only for SNR values being -1dB, 1dB and 3dB are shown. Receivers' BER CDFs are noted to be very similar. At the SNR of 3dB, the probability that $BER \leq 10^{-4}$ is reached, is around 0.2 for the both receivers. Correspondingly, $BER \leq 10^{-3}$ is achieved with the probability around 0.4. At the SNR of 1dB, the probability for achieving such target BER is around 0.2 for the original MIMO SC/MMSE and 0.15 for the turbo equalized diversity. However, receivers' performance difference is more significant in terms of FER: At the SNR of 3dB, the original SC-MMSE achieves a maximum 20% FER with the probability 0.65, whereas for the turbo equalized diversity scheme the probability is 0.3. At the SNR of 1 dB, the original SC/MMSE achieves that target FER with the same probability (0.3) as the turbo equalized diversity at the SNR of 3dB. Hence, if the FER range of practical interest is around those values, the performance loss incurred by splitting the antennas into groups as in the turbo equalized diversity is 2dB. Figure 9, where the average throughput efficiencies are shown for the SNR range [-1dB 1dB 3dB], indicates also the tendency for FER performance difference: At SNR of -1dB the average TP is 0.23 (out of maximum TP=0.5) for the original SC-MMSE equalizer, whereas only 0.04 for the turbo equalized diversity. Poor TP for turbo equalized diversity is due to the numerous snapshots where FER=1, as seen in Fig 8b. However, as the SNR increases, the TP difference between the receivers slightly diminishes.

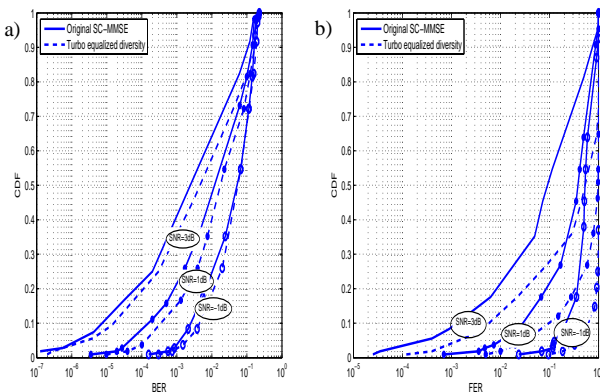

Fig. 8. CDFs for BER (a) and FER (b) of the original MIMO SC/MMSE and turbo equalized diversity equalizer in the single user case.

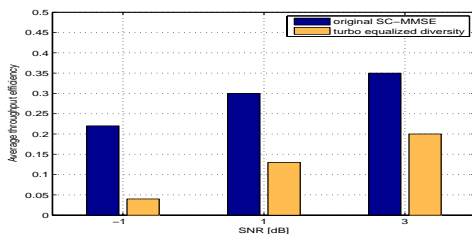

Fig. 9. The average throughput efficiency for the original MIMO SC/MMSE and turbo equalized diversity equalizer in the single user case.

CDFs of the BER and FER performances for the turbo equalized diversity with common SC/MMSE MIMO receiver are shown in Fig. 10a and 10b, respectively. For the comparison, BER and FER CDFs without the vertical iteration are included (dashed line). As noted before, the benefit obtained from the vertical iteration is significant: Probability that the turbo equalized diversity with common SC/MMSE achieves $BER \leq 10^{-3}$ or a maximum FER of 20% is

0.93 with SNR 3dB, and is only slightly less than 0.9 with SNR of 1dB. Instead, corresponding probabilities without performing the vertical iteration are around 0.5 and 0.2. This tendency is found to be similar at lower ranges of BER and FER. The significant impact of the vertical iteration can also be seen by examining the average throughput efficiencies shown in Fig 11. Even at the SNR of -1dB, TP is 0.4 after the vertical iteration, whereas without the vertical iteration, TP is slightly less than 0.2. At higher SNRs, TP without the vertical iteration is also high, and hence, the benefit obtained from the vertical iteration diminishes.

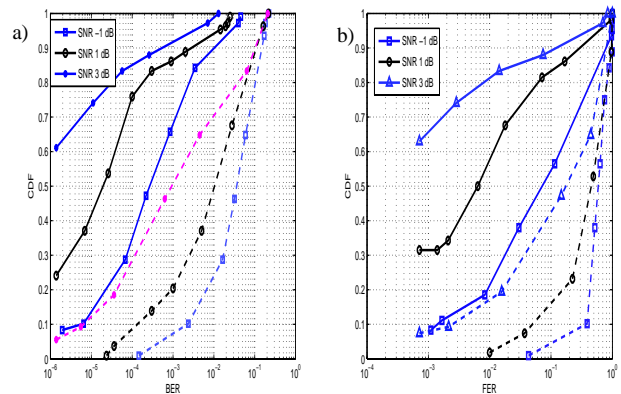

Fig. 10. CDFs for the BER (a) and FER (b) of the turbo equalized diversity with common SC/MMSE MIMO receiver after the vertical iteration (solid lines) and without the vertical iteration (dashed lines) in the single-user case.

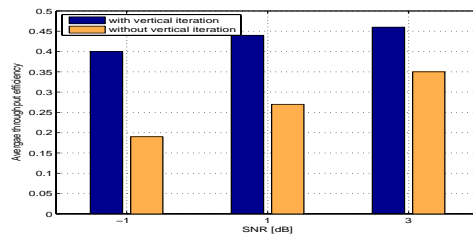

Fig.11. Average throughput efficiency for turbo equalized diversity with common SC/MMSE with and without the vertical iteration, single user case.

Multuser case

Next, performances of the receivers are compared in the presence of two users. Both of the users are randomly located within the measurement route so that they occupy the snapshots at least once. The number of randomly chosen snapshots sets is 200.

The CDFs for the BER and FER performances of the original MIMO SC/MMSE and the turbo equalized diversity receivers are presented in Fig. 12a and Fig. 12b, respectively. It is noted that performances are significantly deteriorated in the presence of multiple users, especially for the turbo equalized diversity receiver. Within the simulated SNR range ([3dB-11dB]), the turbo equalized diversity achieves $BER \leq 10^{-3}$ or a maximum 20% FER only with the probability less than 0.1. The original SC/MMSE achieves those target values with the probability less than 0.1 only with SNR 3dB. With SNR 11dB, $BER \leq 10^{-3}$ and a maximum 20% FER are achieved with the probabilities of 0.4 and 0.3, respectively. Furthermore it is noted that in numerous snapshots within all the SNR values, the FER=1 for the turbo equalized diversity scheme. Hence, the average throughput efficiency shown in Fig. 13, is very low: Even at SNR of 11dB, turbo equalized diversity achieves TP less than 0.15. Instead, the original SC-MMSE can achieve TP of 0.15 at SNR of 3dB and TP of 0.38 at SNR=11dB.

CDFs for BER and FER of the turbo equalized diversity with common SC/MMSE MIMO receiver are shown in Fig. 14a and 14b, respectively. The results prove that the gain obtained from the verti-

cal iteration within the common SC/MMSE part is remarkable also in the presence of multiple users. BER $\leq 10^{-3}$ and a maximum FER of 20 % are achieved with a probability around 0.5 even at SNR of -1dB, whereas without vertical iteration those targets values are hardly achieved within the simulated SNR range [-1dB-3dB]. With SNR 3dB, those BER and FER values are achieved after the vertical iteration with a probability around 0.8. From these results it is obvious that the average throughput efficiency, presented in Fig. 15, is very high after the vertical iteration in all the simulated SNR values. TP without the vertical iteration is clearly worse

5. SUMMARY

Performances of three different MMSE MIMO turbo equalization techniques: original SC/MMSE turbo equalization, the complexity-reduced turbo equalized diversity, and turbo equalized diversity with common SC/MMSE, have been evaluated in realistic scenarios using channel measurement data. The main focus of this paper has been to make system-level assessments in terms of outage probabilities of the BER and FER performance figures obtained by evaluating cumulative probability densities and average throughput efficiencies using the field measurement data. Both single user and multiple user cases were considered.

Performance of all the evaluated SC/MMSE MIMO equalization receivers was found to be significantly depending on propagation conditions in terms of azimuth spreads. In the single user case, the original SC/MMSE MIMO equalizer provides better FER performance than the complexity-reduced turbo equalized diversity receiver. However, the difference in BER performance is minor. In the presence of multiple users, the performance difference between those receivers become more notably. Apparently, the turbo equalized diversity scheme is more sensitive to the channel conditions due to the splitting of the receive antennas into several turbo equalized diversity groups, which brings about a detrimental impact on the signal separability within each group.

The turbo equalized diversity with common SC/MMSE MIMO receiver has been shown to achieve excellent BER and FER performances. The vertical iteration gain, obtained from the LLR exchange between the decoders of the same user within the common SC/MMSE part, has been found to be significant both in single user and multiuser cases.

It should be emphasized that although the system-level performance assessments presented in this paper are valid only in the measurement area where the snapshots were collected, similar tendencies can be expected in similar propagation environments.

REFERENCES

[1] D. Reynolds & X.Wang, "Low-Complexity Equalization for Diversity Channels", *Sign. Proc.*, v. 81, 2002, p. 989-995.
 [2] M. Tuchler, A.C. Singer, & R. Koetter, "Minimum Mean Squared Error Equalization Using a priori Information", in *IEEE trans. on Sign. Proc.*, 2002, V. 50, p. 673-583.
 [3] H. Oomori, T. Asai & T. Matsumoto, "A Matched Filter Approximation for SC/MMSE Turbo Equalizers", in *IEEE Comm. Letter*, vol. 5, 2001, p.310-312.
 [4] K. Kansanen & T. Matsumoto, "A Computationally Efficient MIMO Turbo Equalizer", in *IEEE Veh. Tech. Conf.*, Korea, 2003, Vol.1.
 [5] M. Särestöniemi, K. Kansanen & T. Matsumoto, "Turbo Diversity Technique Based on SC/MMSe Equalizer", in: *IST Summit*, Portugal, 2003, p.100-105.
 [6] M. Tuchler & J. Hagenauer, "Linear Time and Frequency Domain Turbo Equalization", in *IEEE Veh. Tech. Conf.*, 2001, vol. 4, pp. 2773-2777.
 [7] T. Abe & T. Matsumoto, "Space-Time Turbo Equalization and Symbol Detection in Frequency Selective MIMO Channels", in: *IEEE Veh. Tech. Conf.*, Atlantic City, 2001.
 [8] U. Trautwein, T. Matsumoto, C. Schneider, & R. Thomä, "Exploring the Performance of Turbo MIMO Equalization in Real Field Scenarios", in *5th Int. Symp. on Wireless Pers. Multimedia Comm.*, Hawaii, 2002.

[9] C. Schneider, U. Trautwein, T. Matsumoto, and R. Thoma, "Dependency of turbo MIMO Equalizer Performance on Spatial and Temporal Multipath Channel Structure", *IEEE Veh. Tech. Conf.*, Korea, 2003.
 [10] U. Trautwein, C. Schneider, R. Thomä, "Measurement Based Performance Evaluation of Advanced MIMO Transceiver Design", *EURASIP Journal on Applied Signal Processing*, No. 11, 2005, p.1712-1724.
 [11] Channelsounder, www.channelsounder.de
 [12] S. Lin & D. Costello, *Error Control Coding*, Englewood Cliffs, NJ, 1983

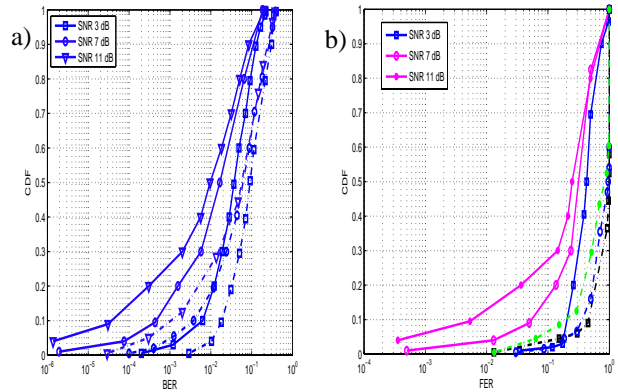

Fig. 12. CDFs for BER (a) and FER (b) of the original MIMO SC/MMSE (solid) and turbo equalized diversity (dashed) in the multiuser case.

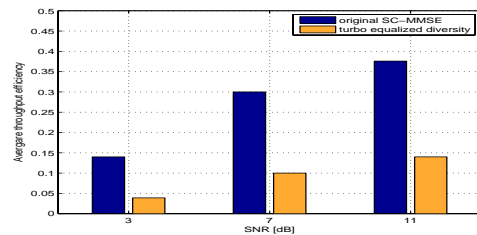

Fig.13. Average throughput efficiency for the original MIMO SC/MMSE and turbo equalized diversity receiver in the multiuser case.

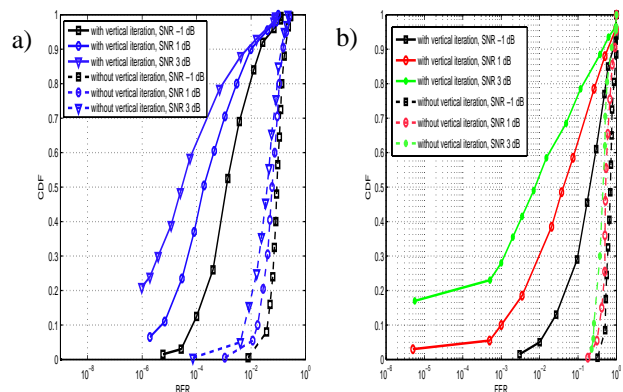

Fig. 14. CDFs for BER (a) and FER (b) of the equalized diversity with common SC/MMSE MIMO receiver after the vertical iteration (solid lines) and without the vertical iteration (dashed lines) in the multiuser case.

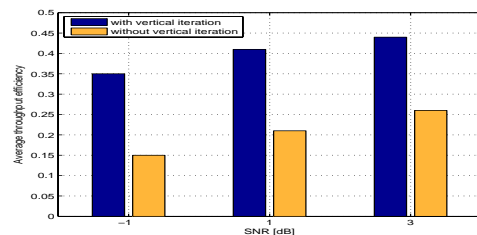

Fig. 15. Average throughput efficiency for the turbo equalized diversity with common SC/MMSE receiver with and without the vertical iteration in the multiuser case.